

Article number: 01010841  
 Description: Retaining ring A 75 DIN 471  
 Stainless 411  
 Note: Fitted with ZGA pilers

## Measures

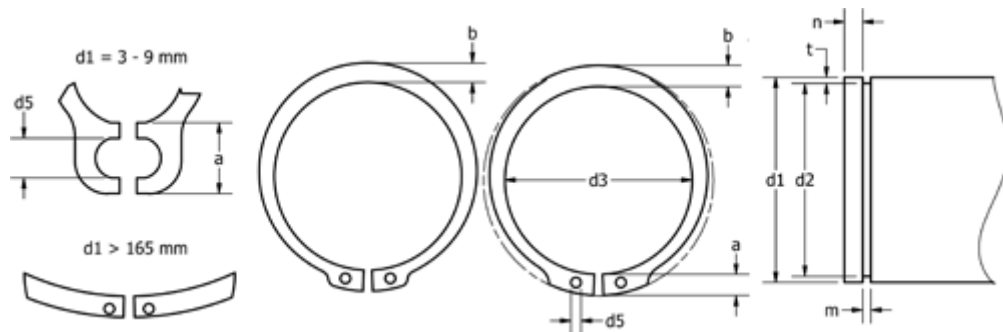

a max	= 8.4	FN kN	= 57.6	s	= 2.50
AN mm <sup>2</sup>	= 346.0	FRg kN	= 22.80	t	= 1.50
b	= 7.0	FR kN	= 130.00	tol	= -0.30
d1	= 75	g	= 2.5	tol	= -0.07
d2	= 72.0	K kN-mm	= 234.00	tol	= +0,46-1,10
d3	= 70.5	m min	= 2.65	Tong	= ZGA-3
d5 min	= 3.0	n abl x 1000	= 6.0	Weight kg/1000	= 24.600
Description	= A75	Nominal drive	= 4.5		